



Catálogo de Accesorios para Equipo Médico



DEMIM

DISTRIBUIDORA DEL GRUPO MEDICO E INDUSTRIAL DE MEXICO S.A. DE C.V.

APLICACION

INDICE	PAGINA
ELECTROCARDIOGRAFO	1
CABLES PARA ELECTROCARDIOGRAFO	2
LEADS PARA ELECTROCARDIOGRAFO	3
PERILLAS Y PINZAS DE EXTREMIDADES	3
ELECTROCIRUGIA	4
CABLES PARA PLACA	5
CONVERTIDORES PARA CABLES DE PLACAS	6
LAPIZ DE ELECTROCIRUGIA	6
PLACAS DESECHABLES CON CABLE	6
PLACAS DESECHABLES SIN CABLE	6
INCUBADORAS	7
CUBIERTAS PARA SENSORES DE TEMPERATURA	8
COLCHON Y FUNDA PARA INCUBADORA	8
FILTROS DE AIRE PARA INCUBADORA	8
MANGAS DE INCUBADORA	9
SENSORES DE TEMPERATURA DESECHABLES PARA INCUBADORA	9
SENSORES DE TEMPERATURA RESUABLES PARA INCUBADORA	10
LAMPARAS DE QUIROFANO	11
MANIJA ESTERILIZABLE	12
MARCAPASEO Y DESFIBRILACION	13
PARCHES PARA MARCAPASEO Y DESFIBRILACION	14
MESA QUIRURGICA	15
PINZAS UNIVERSALES	16
ACCESORIOS GENERALES	16
ACCESORIOS ORTOPEDICOS	18
ALMOHADILLAS	20
BANDEJA DE DRENAJE	21
CARRITO DE TRANSPORTE	21
INTERRUPTOR DE PIE	22
MARCO DE ANESTESIA	22
MONITOREO	23
BRAZALETES PARA PRESION ARTERIAL NO INVASIVA DESECHABLE	24
BRAZALETES PARA PRESION ARTERIAL NO INVASIVA REUSABLES	25
CABLE ECG PARA MONITOR	26
CABLES TRONCALES ECG PARA MONITOR	27
EXTENSIONES PARA SENSOR DE SPO2	28
INTERFACES PARA TRANSDUCTOR DE PRESION INVASIVA	33
JUEGO DE LATIGUILLOS PARA ECG	35
MAQUERAS DE PRESION NO INVASIVA	36
SENSOR DE SPO2 TIPO CLIP - ENVITEC	37
SENSOR DE SPO2 TIPO MULTISITIO - ENVITEC	40
SENSOR DE SPO2 CONEXION DIRECTA TIPO OREJA - ENVITEC	41
SENSOR DE SPO2 TIPO CLIP- UNIMED	42
SENSOR DE SPO2 TIPO MULTISITIO - UNIMED	44
SENSOR DE SPO2 CONEXION DIRECTA TIPO SILICION	46
SENSOR SPO2 DESECHABLES	48
SENSOR DE TEMPERATURA	49
SENSOR IBP	50
ACCESORIOS DE MONITOREO ORIGINALES MINDRAY	51
SIMULADORES	58
SEGURIDAD ELECTRICA	59
SIMULADORES	60
SIMULADORES MODULARES	61
ULTRASONIDO	65
IMPRESORAS B/N	66
IMPRESORAS COLOR	66
PAPEL	67
VENTILACION	68
SENSORES DE FLUJO	69
CELDA DE OXIGENO	70
CIRCUITOS DE RESPIRACION	71

PRODUCTO

INDICE

PAGINA

ACCESORIOS DE MONITOREO ORIGINALES MINDRAY	51
ACCESORIOS GENERALES	16
ACCESORIOS ORTOPEDICOS	18
ALMOHADILLAS	20
BANDEJA DE DRENAJE	21
BRAZALETES PARA PRESION ARTERIAL NO INVASIVA DESECHABLE	24
BRAZALETES PARA PRESION ARTERIAL NO INVASIVA REUSABLES	25
CABLE ECG PARA MONITOR	26
CABLES PARA ELECTROCARDIOGRAFO	2
CABLES PARA PLACA	5
CABLES TRONCALES ECG PARA MONITOR	27
CARRITO DE TRANSPORTE	21
CELDAS DE OXIGENO	70
CIRCUITOS DE RESPIRACION	71
COLCHON Y FUNDA PARA INCUBADORA	8
CONVERTIDORES PARA CABLES DE PLACAS	6
CUBIERTAS PARA SENSORES DE TEMPERATURA	8
EXTENSIONES PARA SENSOR DE SPO2	28
FILTROS DE AIRE PARA INCUBADORA	8
IMPRESORAS B/N	66
IMPRESORAS COLOR	66
INTERFASES PARA TRANSDUCTOR DE PRESION INVASIVA	33
INTERRUPTOR DE PIE	22
JUEGO DE LATIGUILLOS PARA ECG	35
LAPIZ DE ELECTROCIRUGIA	6
MAGUERAS DE PRESION NO INVASIVA	36
MANGAS DE INCUBADORA	9
MANIJA ESTERILIZABLE	12
MARCO DE ANESTESIA	22
PAPEL	67
PARCHES PARA MARCAPASEO Y DESFIBRILACION	14
PERILLAS Y PINZAS DE EXTREMIDADES	3
PINZAS UNIVERSALES	16
PLACAS DESECHABLES CON CABLE	6
PLACAS DESECHABLES SIN CABLE	6
SEGURIDAD ELECTRICA	59
SENSOR DE SPO2 CONEXION DIRECTA TIPO OREJA - ENVITEC	41
SENSOR DE SPO2 CONEXION DIRECTA TIPO SILICION	46
SENSOR DE SPO2 TIPO CLIP - ENVITEC	37
SENSOR DE SPO2 TIPO CLIP- UNIMED	42
SENSOR DE SPO2 TIPO MULTISITIO - ENVITEC	40
SENSOR DE SPO2 TIPO MULTISITIO - UNIMED	44
SENSOR DE TEMPERATURA	49
SENSOR IBP	50
SENSOR SPO2 DESECHABLES	48
SENSORES DE FLUJO	69
SENSORES DE TEMPERATURA DESECHABLES PARA INCUBADORA	9
SENSORES DE TEMPERATURA RESUABLES PARA INCUBADORA	10
SIMULADORES	60
SIMULADORES MODULARES	61

MARCA

INDICE

PAGINA

INDICE	PAGINA
ENVITEC	
SENSORES DE FLUJO	X
SENSORES DE SPO2 CONEXION DIRECTA TIPO CLIP	X
SENSORES DE SPO2 CONEXION DIRECTA TIPO MULTISITIO	X
SENSORES DE SPO2 CONEXION DIRECTA TIPO SILICON	X
SENSORES DE SPO2 DE CLIP	X
SENSORES DE SPO2 DESECHABLES	X
SENSORES DE SPO2 MULTISITIO	X
MINDRAY	
ADAPTADORES DE LINEA AEREA CO2	X
ALMOHADILLAS	X
AMPLIFICADOR BIS	X
BRAZALETE NEONATAL	X
BRAZALETE PARA PRESION NO INVASIVA	X
CABLE BIFURCADO MEC	X
CABLES TRONCALES DE ECG	X
CUENCA DE DRENAJE	X
ELECTRODOS BIS	X
JUEGOS DE LATIGUILLOS	X
LINEAS DE MUESTREO DE CAPNOGRAFIA	X
LINEAS DE MUESTREO DE CO2	X
MANGAS DE INCUBADORA	X
MANGUERAS DE PRESION NO INVASIVA	X
MANIJAS	X
MARCO DE ANESTESIA	X
PINZA UNIVERSAL	X
POSTE DE INFUSION	X
SENSORES DE FLUJO	X
SOPORTE DE BRAZO	X
SOPORTE DE CABEZA	X
SOPORTE DE CUERPO	X
SOPORTE DE MANO	X
SOPORTE DE PIE	X
SOPORTE DE PIERNA	X
TRAMPAS DE AGUA PARA CO2	X
SKINTACT	
ADAPTADORES PARA PLACA	X
CABLES BIPOLARES	X
CABLES PARA PLACA DE DESECHABLE	X
LAPIZ DE ELECTROCIRUGIA	X
PARCHES PARA MARCAPASEO Y DESFIBRILACION	X
PLACAS DE RETORNO DESECHABLES	X
PLACAS DE RETORNO REUSABLES DE SILICON	X
TARRY	
COLCHONES Y FUNDAS PARA CUNAS TERMICAS	X
CUBIERTAS PARA SENSORES DE TEMPERATURA	X
FILTROS DE AIRE PARA INCUBADORAS	X
MANGAS DE INCUBADORA	X
PLACAS DE RETORNO DESECHABLES	X
PLACAS DE RETORNO REUSABLES DE SILICON	X
SENSORES DE TEMPERATURA REUSABLES	X
UNIMED	
BRAZALETE NEONATAL	X
BRAZALETE PARA PRESION NO INVASIVA	X
CABLES DE ECG COMPLETOS	X
CABLES PARA ELECTROCARDIOGRAFO	X
CABLES TRONCALES DE ECG	X
EXTENSIONES DE SPO2	X
JUEGOS DE LATIGUILLOS	X
MANGUERAS DE PRESION NO INVASIVA	X
PERILLAS PRECORDIALES	X
PINZAS DE EXTREMIDADES	X

SENSORES DE SPO2 CONEXION DIRECTA TIPO CLIP	X
SENSORES DE SPO2 CONEXION DIRECTA TIPO MULTISITIO	X
SENSORES DE SPO2 CONEXION DIRECTA TIPO SILICON	X
SENSORES DE SPO2 CONEXION DIRECTA TIPO OREJA	X
SENSORES DE SPO2 DE CLIP	X
SENSORES DE SPO2 DESECHABLES	X
SENSORES DE SPO2 MULTISITIO	X

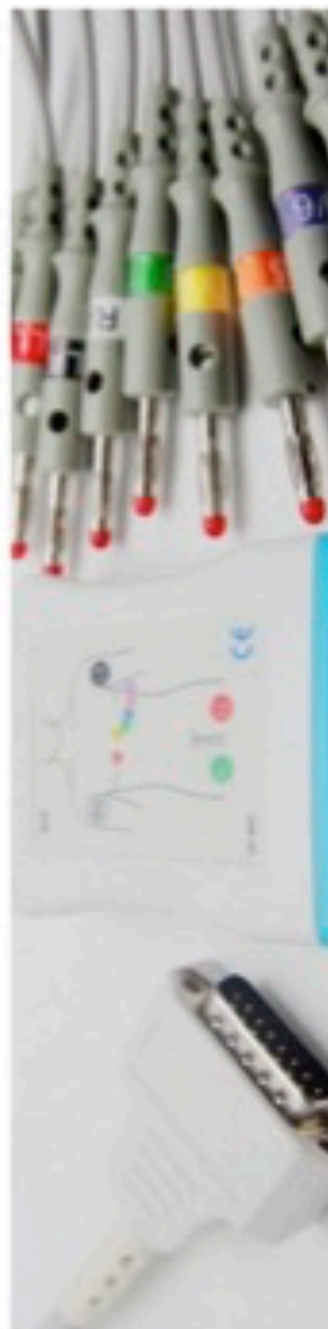

ELECTROCARDIOGRAFO

CABLE DE ELECTROCARDIOGRAFO**CONECTOR****CAMPATIBILIDAD****No. PARTE**

BOSCH, CAMBRIDGE MODELOS VS6, SC 1000, CARDIOLINE, MODELOS E1, R/3, DELTA 3/300/360 CARDIONICS, HELIGE, HONEYWELL/PHILIPS, POLYMED, SCHARZER, SECA, BURDICK, MODELOS: ECLIPSE, ELITE, E350, FUKUDA, NIHON KOHDEN

E10-NK2-B

BOSCH, CAMBRIDGE, HELIGE, SIEMENS, MODELOS CARDIOSTART, CARDINA, CARDIREX, CATHCOR, MEGACARD ELEMA, MICOLOC, MICOGRAPH, MINGOLOG, MINGOPHON, MIRACARD, SIRECARD, SIREG, SIRECUST, CARDIOSTAT

E10-HL-B

BURDICK MODELOS ECLIPSE4, ECLIPSE 400, ECLIPSE 8, ECLIPSE 800, ECLIPSE 850, ECLIPSE 850I, ECLIPSE PLUS, ECLIPSE LEIL, ATRIA

E10-BK2-B

BURDICK MODELOS EK10, E550, E560

E10-BK1-B

KENZ MODELOS 103, 106 CARDIOLINE MODELOS DELTA 1, 3, 30, 60, DELTA 1 PLUS, DELTA 3 PLUS, DELTA 60 PLUS

E10-KZ-B

MARQUETTE (GEMS) MODELOS MICROSMART, MAC 500/1100, MAC 1200/1200T

E10-MQ5-B

MORTARA MODELOS ELI 100, ELI 200, ELI 50

E10-MT-B



PHILIPS MODELOS M1770A, PAGE WRITER 200I, M1771A PAGE WRITER 200, M1772A PAGE WRITER 100

E10-HP-B





SCHILLER MODELOS AT1, AT2, AT3, AT4, AT5, AT6, AT10, AT60, AT104, AT101, AT102, DEL MAR AVIONICS, CUSTO MED ERGOLINE, ESAOTE BIOMEDICA, FIDELITY, KONTRON, REYNOLDS

E10-SH1-B

LEADS PARA ELECTROCARDIOGRAFO

	DESCRIPCION	No. PARTE
	EKG LEADS GE- MARQUETTE (JUEGO CON 10)	MQD10-LB
	EKG LEADS PHILIPS B7 (JUEGO CON 10)	PW10-LB
	ADAPTADORES DE BANANA A BROCHE PARA CABLE DE EKG, JUEGO DE 10 PIEZAS	AD-B-S

PERILLAS Y PINZAS DE ELECTROCARDIOGRAFO

	DESCRIPCION	No. PARTE
	JUEGO DE PINZAS DE EXTREMIDADES ADULTO	UU-LC-A
	JUEGO DE PINZAS DE EXTREMIDADES PEDIATRICAS	UU-LC-P
	PERILLA PRECORDIAL PLATA-CLORURO DE PLATA ADULTO PAQUETE CON 6	UU-SE-A
	PERILLA PRECORDIAL PLATA-CLORURO DE PLATA PEDIATRICA PAQUETE CON 6	UU-SE-P



ELECTROCIRUGIA

CABLES PARA PLACA



	DESCRIPCIÓN	No. PARTE
	CABLE REUSABLE PARA PLACA DESECHABLE DE ELECTROCIRUGIA TIPO REM	NEK300A
	CABLE REUSABLE PARA PLACA DESECHABLE DE ELECTROCIRUGIA TIPO NO REM	NEK300B
	CABLE REUSABLE PARA PLACA DESECHABLE DE ELECTROCIRUGIA JACK ESTANDAR DE 6.3 mm	NEK 300D
	CABLE REUSABLE PARA PLACA DESECHABLE DE ELECTROCIRUGIA TIPO BANANA 4mm	NEK 300E
	CABLE REUSABLE PARA PLACA DESECHABLE DE ELECTROCIRUGIA TIPO ESCHMANN	NEK 300G
	CABLE REUSABLE PARA PLACA DESECHABLE DE ELECTROCIRUGIA TIPO ERBE	NEK 300H

CONVERTIDORES PARA CABLES DE PLACAS

	DESCRIPCIÓN	No. PARTE
	CONVERTIDOR PARA PLACA VALLEY LAB A JACK ESTANDAR DE 6.3 mm	NEKA-AD
	CONVERTIDOR PARA PLACA VALLEY LAB A ERBE	NEKA-AH

LAPIZ DE ELECTROCIRUGIA

	DESCRIPCIÓN	No. PARTE
	LAPIZ CON SELECTOR DE CORTE Y COAGULACION CABLE DE 3 MTS DE LONGITUD HOJA ESTANDAR	HCP01

PLACAS DESECHABLES CON CABLE

RO-21A30 PLACA DESECHABLE PARA ELECTROCIRUGIA TIPO REM CON CABLE DE 3.0M	RO-01B30 PLACA DESECHABLE PARA ELECTROCIRUGIA TIPO NO CON CABLE DE 3.0M

PLACAS DESECHABLES SIN CABLE



RO-21 PLACA DESECHABLE PARA ELECTROCIRUGIA TIPO REM SIN CABLE	RO-01 PLACA DESECHABLE PARA ELECTROCIRUGIA TIPO NO REM SIN CABLE



Tarry
MUNDO DE NEONATOS

INCUBADORAS

CUBIERTAS PARA SENSORES DE TEMPERATURA



CONECTOR	DESCRIPCION	No. PARTE	CONECTOR	DESCRIPCION	No. PARTE
	CUBIERTA HYDROCOLOIDE MEZCLA COLOR ORO Y PLATA TAMAÑO GRANDE FORMA CORAZON TAMAÑO 1 1/4" CAJA CON 50	T 80202		CUBIERTA HYDROCOLOIDE MEZCLA COLOR ROSA Y AZUL TAMAÑO GRANDE FORMA CORAZON TAMAÑO 1 1/4" CAJA CON 50	T 80212
	CUBIERTA DE HIDROGEL COLOR PLATA GRANDE TAMAÑO 1" X 1/4" CAJA CON 60	T 80425		CUBIERTA DE FORMA REDONDA TAMAÑO 1 1/4" CAJA CON 500	T 80150

COLCHON Y FUNDA PARA INCUBADORA

CONECTOR	DESCRIPCION	No. PARTE	CONECTOR	DESCRIPCION	No. PARTE
	COLCHON PARA INCUBADORA AIR SHIELDS C86 Y C100 TAMAÑO 14" X 24" X 1" CAJA CON 10	T 11770		FUNDA PARA COLCHON DE INCUBADORA AIR SHIELDS C86, C100, CAJA CON 10	T 11800

FILTROS DE AIRE PARA INCUBADORA





CONECTOR	DESCRIPCION	No. PARTE	CONECTOR	DESCRIPCION	No. PARTE
	MICROFILTRO PARA INCUBADORA SHIELDS MODELO T167, C100, C300 Y C500 TAMAÑO 3" X 8 1/2" CAJA CON 6	T 07075		MICROFILTRO PARA INCUBADORA AIR SHIELDS DE TRANSPORTE TAMAÑO 4" X 4" CAJA DE 10	T 93070
	MICROFILTRO PARA INCUBADORA AIR SHIELDS ISOLETTE C2000 TAMAÑO 3 1/8" X 5 9/16" CAJA CON 4	T 10130		MICROFILTRO PARA INCUBADORA OHMEDA IC, CAREPLUS Y 190 SERIES TAMAÑO 6 1/2" X 11 1/2"	T 15870
	MICROFILTRO PARA INCUBADORA AIR SHIELDS DEWETTE TAMAÑO 6" X 24" CAJA CON 4	T 12640		MICROFILTRO PARA INCUBADORA OHMEDA TRANSPORTE TAMAÑO 3 1/2" X 5"	T 44300
	MICROFILTRO PARA INCUBADORA AIR SHIELDS C86, C300, C500, TAMAÑO 6" X 24" CAJA CON 4	T 94570		MICROFILTRO PARA INCUBADORA OHMEDA IC TAMAÑO 9" X 3 1/4" CAJA CON 5	T 71600

CONECTOR	DESCRIPCION	No. PARTE	CONECTOR	DESCRIPCION	No. PARTE
	MICROFILTRO PARA INCUBADORA ATOM V-80, V-85, V-850, SERIES TAMAÑO 6 1/2"X 20"	T 94680		MICROFILTRO PARA INCUBADORA OHMEDA GIRAFFE CAJA CON 10	T 07850
	MICROFILTRO PARA INCUBADORA ATOM Y 2100 SERIES CAJA CON 5	T 21146		MICROFILTRO PARA INCUBADORA MEDIX PC-305 CAJA CON 4	T 94533







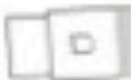

MANGAS PARA INCUBADORA

CONECTOR	DESCRIPCION	No. PARTE	CONECTOR	DESCRIPCION	No. PARTE
	MANGAS DE ACCESO PARA INCUBADORA AIR SHIELDS MODELOS C100, C200, C300, TRANSPORTE	T 93481		MANGAS IRIS PARA INCUBADORA AIR SHIELDS C77, C86 Y C200	T 61500

SENSORES DE TEMPERATURA DESECHABLE PARA INCUBADORA

CONECTOR	DESCRIPCION	No. PARTE	CONECTOR	DESCRIPCION	No. PARTE
	SENSOR DE TEMPERATURA PARA INCUBADORA AIR SHIELDS C100, C200, C450, C550 Y ICS 90	T 100		SENSOR DE TEMPERATURA PARA INCUBADORA DRACER CALEO	T 11000
	PARA USO CON INCUBADORAS OHMEDA IC, CC, CARE PLUS	T 3000		PARA USO CON INCUBADORAS OHMEDA GIRAFFE Y PANDA WARMER	T 08730
	PARA USO CON INCUBADORAS AIR SHIELDS C 2000	T 10415			

SENSORES DE TEMPERATURA REUSABLES PARA INCUBADORA

CONECTOR	DESCRIPCION	No. PARTE	CONECTOR	DESCRIPCION	No. PARTE
 	SENSOR DE TEMPERATURA REUSABLE PARA CUNA DE RADIANTE AIR SHIELDS ICS 90 Y BIRTH ROOM WARM	T 20970	 	SENSOR DE TEMPERATURA REUSABLE PARA INCUBADORA AIR SHIELDS C2000	T 10241
 	SENSOR DE TEMPERATURA DE AIRE REUSABLE PARA INCUBADORA AIR SHIELDS C100 Y C200	T 20980		SENSOR DE TEMPERATURA REUSABLE PARA INCUBADORA OHMEDA 3000 Y 5000 SERIES	T 97700
 	SENSOR DE TEMPERATURA REUSABLE PARA CUNA TERMICA AIR SHIELDS RESUSCITAIRE INFANT RADIANT WARMER	T 11225	 	SENSOR DE TEMPERATURA REUSABLE PARA INCUBADORA OHMEDIA GIRAFFE	T 08750

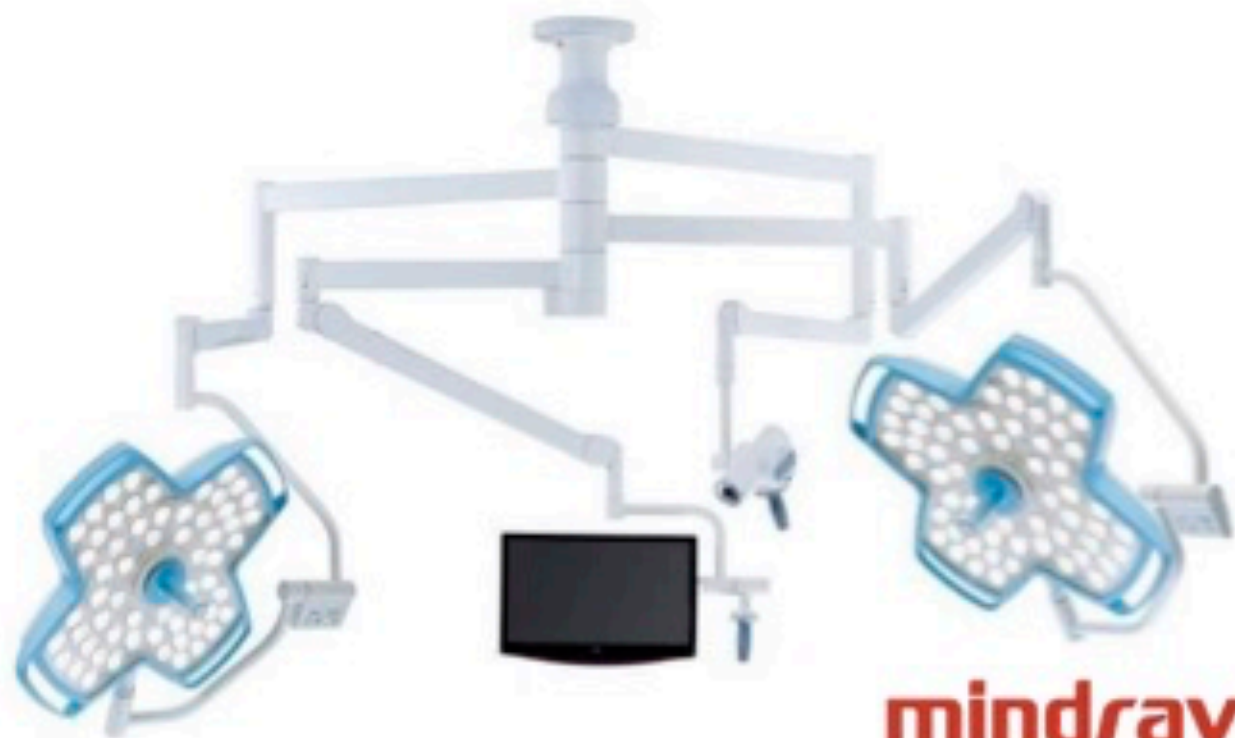

LAMPARAS DE
QUIROFANO

SENSORES DE TEMPERATURA RESUSABLES PARA INCUBADORA

	DESCRIPCION	No. PARTE
	MANIJA ESTIRILIZABLE	115-006128-00





SKINTACT®



**MARCAPASEO Y
DEFIBRILACION**

PARCHES PARA MARCAPASEO Y DESFIBRILACION

CONECTOR	DESCRIPCIÓN	No. PARTE
	PARCHE COMPATIBLE CON DESFIBRILADORES: PHYSIO CONTROL (MEDTRONIC) MINDRAY	DF 20N
	PARCHE COMPATIBLE CON DESFIBRILADORES SCHILLER	DF 25N
	PARCHE COMPATIBLE CON DESFIBRILADORES PHILIPS CODEMASTER	DF 26N
	PARCHE COMPATIBLE CON DESFIBRILADORES PHILIPS HEARTSTART	DF 27N
	PARCHE COMPATIBLE CON DESFIBRILADORES ZOLL	DF 28N
	PARCHE COMPATIBLE CON DESFIBRILADORES WELCH ALLYN	DF 29N



**MESA
QUIRURGICA**

PINZAS UNIVERSALES

DESCRIPCION		No. PARTE	DESCRIPCION		No. PARTE
	PINZA UNIVERSAL PARA RIELES PESO LIGERO, RADIAL, UNA PIEZA 1KG 160X120X60mm	0092-30-102658		PINZA UNIVERSAL PARA RIELES, RADIAL, UNA PIEZA 0.9KG 160X120X70mm	0092-30-102656
	PINZA UNIVERSAL PARA RIELES PESO LIGERO, UNA PIEZA, CUADRADO 0.4KG 90X50X50mm	0092-30-102657		PINZA UNIVERSAL PARA RIELES, UNA PIEZA, CUADRADO 0.6KG 120X100X90mm	0092-30-102655

ACCESORIOS GENERALES

DESCRIPCION		No. PARTE	DESCRIPCION		No. PARTE
	SOPORTE PARA POSICION LATERAL DE BRAZOS	0092-30-102648		SOPORTE ELEVADIZO Y ROTACIONAL PARA BRAZO	0092-30-102634
	SOPORTE ROTACIONAL PARA BRAZO EN POSICION HORIZONTAL	0092-30-102646		POSTE DE INFUSION	0092-30-102643
	CORREO CORPORAL	0092-30-102640		SOPORTES PARA PIERNAS	0092-30-102635
	SOPORTE BASICO DE HOMBROS	0092-30-102649		SOPORTE GRANDE PARA PIERNAS	115-005685-00
	SOPORTE BASICO DE HOMBRO IZQUIERDO	0092-30-102637		SOPORTE GRANDE DE CUERPO	0092-30-102638

	DESCRIPCION	No. PARTE		DESCRIPCION	No. PARTE
	SOPORTE UNIVERSAL DE DOS PIEZAS PARA CUERPO	0092-30-102650		SOPORTE DE PIE IZQUIERDO	0092-30-102636
	ADAPTADOR PARA SOPORTE NEUROLOGICO DE HERRADURA	0092-30-102642		SOPORTE AJUSTABLE EN FORMA DE HERRADURA PARA CABEZA	115-005695-00
	SOPORTE PARA RAYOS X	0092-30-102641		SOPORTE DE PIERNAS CON AROS	115-007043-00
	SOPORTE PARA CIRUGIA OFTALMICA	115-007045-00		SOPORTE PARA POSICION RECTAL	115-007049-00
	SOPORTE PARA BRAZO CON ARO	115-007051-00		MUÑEQUERAS	115-007053-00
	MESA PARA CIRUGIA DE BRAZO	115-007047-00		SOPORTE PARA CIRUGIA DE VERTEBRA	0092-30-102639



ACCESORIOS ORTOPEDICOS

		DESCRIPCION	No. PARTE	
		EXTENSION ORTOPEDICO CON CARRITO DE TRANSPORTE	115-009425-00	
		EXTENSION LATERAL DEL FEMUR	115-007057-00	
				
EXTENSION DE SOPORTE	CONTRAPIRO DE FEMUR	ABRAZADERA DE TRACCION	SOPORTE UNIVERSAL DE PIERNA	SOPORTE PARA PIE



				DESCRIPCION	No. PARTE
				EXTENSION PARA TIBIA	115-007055-00
ABRAZADERA DE TRACCION	CONTRATIRO DE TIBIA Y PERONE	ADAPTADOR PARA EXTENSION DE TORNILLO	SOPORTE PARA PIERNA		

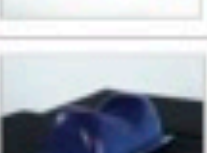

ALMOHADILLAS

	DESCRIPCION	No. PARTE		DESCRIPCION	No. PARTE
	ALMOHADILLA PARA POSICION DECUBITO	115-005864-00		ALMOHADILLA EN ROSCA PARA CABEZA	115-005872-00
	ALMOHADILLA EN HERRADURA PARA CABEZA	115-005885-00		ALMOHADILLA PARA POSICION SUPINA	115-005892-00
	ALMOHADILLA OFTALMICA	115-005896-00		ALMOHADILLA UNIVERSAL PARA CABEZA	115-005900-00
	ALMOHADILLA UNIVERSAL PARA BRAZO	115-005904-00		ALMOHADILLA PROTECTORA PARA CODOS	115-005906-00
	ALMOHADILLA PROTECTORA PARA MUÑECAS	115-005908-00		ALMOHADILLAS LATERALES	115-005910-00
	ALMOHADILLA PARA POSICION DECUBITO	115-005788-00		ALMOHADILLA PARA CADERA O PECHO	115-005790-00
	ALMOHADILLA PARA CADERA CON BURBUJA	115-005792-00		ALMOHADILLA PARA FRACTURA	115-005794-00
	ALMOHADILLA PROTECTORA PARA CUERPO	115-005796-00		ALMOHADILLA UNIVERSAL EN FORMA DE DOMO	115-005808-00
	ALMOHADILLA LATERAL PARA PIERNA O BRAZO	115-005811-00		ALMOHADILLA PARA TOBILLOS	115-005814-00

ALMOHADILLAS

	DESCRIPCION	No. PARTE		DESCRIPCION	No. PARTE
	ALMOHADILLA CUADRADA UNIVERSAL	115-005818-00		ALMOHADILLA PROTECTORA PARA TOBILLOS	115-005822-00
	ALMOHADILLA PARA CAMA	115-005826-00			

BANDEJA DE DRENAJE

CONECTOR	DESCRIPCIÓN	No. PARTE
	BANDEJA DE DRENAJE PARA GINECOLOGIA Y UROLOGIA	115-005697-00

CARRITO DE TRANSPORTE

CONECTOR	DESCRIPCIÓN	No. PARTE
	CARRITO DE ACCESORIOS	115-008220-00

INTERRUPTOR DE PIE

CONECTOR	DESCRIPCIÓN	No. PARTE
	INTERRUPTOR DE PIE	0092-30-102644

MARCO DE ANESTESIA

CONECTOR	DESCRIPCIÓN	No. PARTE
	MARCO DE ANESTESIA EN FORMA "U"	115-005689-00
	MARCO DE ANESTESIA EN FORMA "L"	0092-30-102645
	MARCO DE ANESTESIA EN FORMA "L" CON 2 TUBOS AJUSTABLES	0092-30-102654





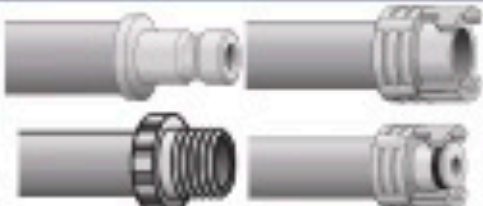
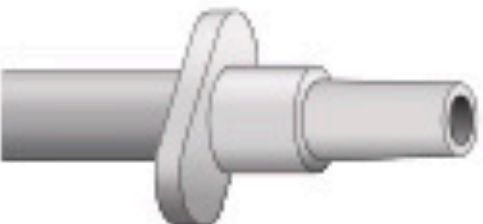

BRAZALETES PARA PRESION ARTERIAL NO INVASIVA DESCEHABLES







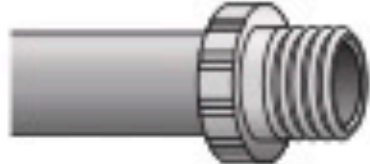

















TIPO PACIENTE	MEDIDA	# DE VIAS	# DE PARTE	CONECTORES DISPONIBLES
ADULTO	23-33 CM	1 VIA	U1740S	
		2 VIAS	U1740D	
NEONATAL	3-6 CM	1 VIA	U1681S	
		2 VIAS	U1681D	
NEONATAL	4-8 CM	1 VIA	U1682S	
		2 VIAS	U1682D	
NEONATAL	6-11 CM	1 VIA	U1683S	
		2 VIAS	U1683D	
NEONATAL	7-13 CM	1 VIA	U1684S	
		2 VIAS	U1684D	
NEONATAL	8-15 CM	1 VIA	U1685S	
		2 VIAS	U1685D	

BRAZALETES PARA PRESION ARTERIAL NO INVASIVA REUSABLES



TIPO PACIENTE	MEDIDA	# DE VIAS	# DE PARTE	CONECTORES DISPONIBLES
NEONATAL	6-11 CM	1 VIA	U1883S	   
		2 VIAS	U1883D	
INFANTIL	10-19 CM	1 VIA	U1882S	
		2 VIAS	U1882D	
PEDIATRICO/ADULTO PEQUEÑO	17-26 CM	1 VIA	U1885S	
		2 VIAS	U1885D	
ADULTO NORMAL	25-35 CM	1 VIA	U1880S	
		2 VIAS	U1880D	
ADULTO GRANDE	33-47 CM	1 VIA	U1869S	
		2 VIAS	U1869D	
MUSLO	46-66 CM	1 VIA	U1884S	
		2 VIAS	U1884D	

CABLE ECG PARA MONITOR

CONECTOR	DESCRIPCION	No. PARTE	CONECTOR	DESCRIPCION	No. PARTE
	MULTIMARCA: BCL, CRITICARE, GE, MEDICAL, IVY, MDE, PHYSIO-CONTROL, NELLCOR, PHILIPS, SPACELABS, WA, ZOLL	2340-P/S 3 puntas 2540-P/S 5 puntas		DATASCOPE	2340-P/S 3 puntas 2540-P/S 5 puntas
	DATEX	2395-P/S 3 puntas 2595-P/S 5 puntas		DRAGER	2377-P/S 3 puntas 2377-P/S 5 puntas
	FLUKUDA	2599-P/S 3 puntas 2599-P/S 5 puntas		MARQUETE	2386-P/S 3 puntas 2586-P/S 5 puntas
	MEX	2310-P/S 3 puntas 2510-P/S 5 puntas		MENNEN	2374-P/S 3 puntas 2574-P/S 5 puntas
	GOLDWAY / MINDRAY	2340-P/S 3 puntas 2540-P/S 5 puntas		MINDRAY	2312-P/S 3 puntas 2512-P/S 5 puntas
	PHILIPS 12 PINES	2385-P/S 3 puntas 2585-P/S 5 puntas		PHILIPS 8 PINES	23029-P/S 3 puntas 25029-P/S 5 puntas
	PHYSIO CONTROL	2327-P/S 3 puntas 2527-P/S 5 puntas		WELCH-ALLYN	2340-P/S 3 puntas 2540-P/S 5 puntas
	SPACELABS	2396-P/S 3 puntas 2596-P/S 5 puntas		BRUKER	EA017C3H
	KONTRON	2398P 3 puntas		NHON KOHDEN	2309-P/S 3 puntas 2509-P/S 5 puntas
	BIONET	2514-P/S 5 puntas		GE-HELLIGE/ GE	2355-P/S 3 puntas 2555-P/S 5 puntas
	MENNEN ENVOY	2375-P/S 3 puntas 2575-P/S 5 puntas			



























No. Parte + S









No. Parte + P



CABLES TRONCALES ECG PARA MONITOR

CONECTOR	DESCRIPCION	No. PARTE	CONECTOR	DESCRIPCION	No. PARTE
 	MULTIMARCA; BCI, CRITICARE, DATA SCOPE, GOLDWAY, IVY, MINDRAY, MDE, PHYSIO-CONTROL, NELLCOR, PHILIPS, SPACELABS, WELCH ALLYN, ZOLL	D-1340 3 puntas D-1540 5 puntas	 	MULTIMARCA; BCI, CRITICARE, GE MEDICAL, IVY, MDE, PHYSIO-CONTROL, NELLCOR, PHILIPS, SPACELABS, WA, ZOLL	LL-2340 3 puntas LL-2540 5 puntas
 	DATASCOPE PASSPORT V	DT-2526 5 puntas	 	DRAGER	SM-5TES 5 puntas
 	DATEX	DX-2395 3 puntas DX-2595 5 puntas	 	NIHON KOHDEN	NK-2509 5 puntas
 	MARQUETE	MQ-2586 5 puntas	 	PHILIPS 8 PINES	AA-23029 3 puntas AA-25029 5 puntas
 	MENNEN ENVOY	AA-2375 3 puntas AA-2375 5 puntas	 	PPG/HELLIGE	DX-2355 3 puntas DX-2555 5 puntas
 	PHILIPS 12 PINES	AA-2385 3 puntas AA-2585 5 puntas	 	SPACELABS	SL-2396 3 puntas SL-2596 5 puntas
 	SIEMENS	SM-2376 3 puntas SM-2576 5 puntas			

CONECTOR	DESCRIPCION	No. PARTE	CONECTOR	DESCRIPCION	No. PARTE
 	GE MARQUETTE NELLCOR OXI	U710X-21	 	GE MARQUETTE NELLCOR	U708-21
 	GE MARQUETTE MASIMO / NELLCOR	U708-21M	 	GE MARQUETTE MASIMO	U708M-21P
 	GOLDWAY / NELLCOR	U708-11	 	GE MARQUETTE OHMEDA	U710-121
 	GOLDWAY/ NELLCOR OXI	U710X-38	 	GOLDWAY/ NELLCOR	U708-37
 	INVIVO NELLCOR	U708-14	 	INVIVO MASIMO	U708M-14P
 	INVIVO MASIMO/ NELLCOR	U708-14M	 	MASIMO / NELLCOR	U708-15

CONECTOR	DESCRIPCION	No. PARTE	CONECTOR	DESCRIPCION	No. PARTE
 	MASIMO / LNOP SENSOR	U708M-15P	 	MEK	U708-26
 	MEK	U708-56	 	MENNEN MASI/ NELLCOR	U708-59M
 	MENNEN/ NELCOR	U708-54	 	MINDRAY	U708-29
 	MINDRAY	U708-29M	 	MINDRAY/ NELLCOR	U708-22
 	MINDRAY/ MASI NELLCOR	U708-22M	 	MINDRAY T5/T8 NELLCOR	U708-48
 	MINDRAY T5/T8 NELLCOR OK	U710X-48	 	MINDRAY T5/T8 MASI A NELLCOR	U708-48M

CONECTOR	DESCRIPCION	No. PARTE	CONECTOR	DESCRIPCION	No. PARTE
 A MONITOR  A SENSOR	NELLCOR SCP10	U708-69	 A MONITOR  A SENSOR	NELLCOR EC8	U708-01
 A MONITOR  A SENSOR	NELLCOR OXI DEC8	U708-71P	 A MONITOR  A SENSOR	NELLCOR OXI DEC 10	U710-70
 A MONITOR  A SENSOR	NONIN LEMO	U708-08	 A MONITOR  A SENSOR	NIHON KOHDEN RECTANGULAR	U710-36
 A MONITOR  A SENSOR	NOVAMETRIX	U708-03	 A MONITOR  A SENSOR	PHILIPS NELLCOR	U708-43 U710X-43 (OXI)
 A MONITOR  A SENSOR	PHILIPS	U708-41	 A MONITOR  A SENSOR	PHILIPS NELLCOR	U708-20
 A MONITOR  A SENSOR	BIONET	U708-108			

CONECTOR	DESCRIPCION	No. PARTE	CONECTOR	DESCRIPCION	No. PARTE
	PHILIPS	U708-40		S&W ARTEMA	U708-80
	SIEMENS	U708-23		SIEMENS SIRACUST	U708-33
	SPACELABS	U708-04		SPACELABS NELLCOR	U708-74
	SPACELABS NELLCOR OXI	U710X-74		SPACELABS MASIM	U708M-74















INTERFACES PARA TRANSDUCTOR DE PRESION INVASIVA

							
	Argon	B. Bruan	BD	Edward	Medex Abbott	Utah	Medex Logical
Criticare 	BC-CSI-AG	BC-CSI-BB	BC-CSI-BD	BC-CSI-ED	BC-CSI-MX	BC-CSI-UT	BC-CSI-MX1
GE- Datex 	BC-DX-AG	BC-DX-BB	BC-DX-BD	BC-DX-ED	BC-DX-MX	BC-DX-UT	BC-DX-MX1
GE-Heilige 	BC-HL-AG	BC-HL-BB	BC-HL-BD	BC-HL-ED	BC-HL-MX	BC-HL-UT	BC-HL-MX1
GE Marquette 	BC-MQ-AG	BC-MQ-BB	BC-MQ-BD	BC-MQ-ED	BC-MQ-MX	BC-MQ-UT	BC-MQ-MX1
Mennen 	BC-MN-AG	BC-MN-BB	BC-MN-BD	BC-MN-ED	BC-MN-MX	BC-MN-UT	BC-MN-MX1
Mindray 	BC-MR-AG	BC-MR-BB	BC-MR-BD	BC-MR-ED	BC-MR-MX	BC-MR-UT	BC-MR-MX1
Philips 	BC-HP-AG	BC-HP-BB	BC-HP-BD	BC-HP-ED	BC-HP-MX	BC-HP-UT	BC-HP-MX1
Spacelabs 	BC-6P-AG	BC-6P-BB	BC-6P-BD	BC-6P-ED	BC-6P-MX	BC-6P-UT	BC-6P-MX1
Siemens 	BC-SM1-AG	BC-SM1-BB	BC-SM1-BD	BC-SM1-ED	BC-SM1-MX	BC-SM1-UT	BC-SM1-MX1





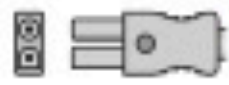









							
	Argon	B. Bruan	BD	Edward	Medex Abbott	Utah	Medex Logical
Siemens 	BC-SM2-AG	BC-SM2-BB	BC-SM2-BD	BC-SM2-ED	BC-SM2-MX	BC-SM2-UT	BC-SM2-MX1
Dräger 	BC-DR-AG	BC-DR-BB	BC-DR-BD	BC-DR-ED	BC-DR-MX	BC-DR-UT	BC-DR-MX1
Datascope 	BC-DT-AG	BC-DT-BB	BC-DT-BD	BC-DT-ED	BC-DT-MX	BC-DT-UT	BC-DT-MX1
Nihon Kohden 	BC-NK1-AG	BC-NK1-BB	BC-NK1-BD	BC-NK1-ED	BC-NK1-MX	BC-NK1-UT	BC-NK1-MX1
	BC-NK2-AG	BC-NK2-BB	BC-NK2-BD	BC-NK2-ED	BC-NK2-MX	BC-NK2-UT	BC-NK2-MX1
Kontron 	BC-KNT-AG	BC-KNT-BB	BC-KNT-BD	BC-KNT-ED	BC-KNT-MX	BC-KNT-UT	BC-KNT-MX1
Spacelabs 	BC-SL-AG	BC-SL-BB	BC-SL-BD	BC-SL-ED	BC-SL-MX	BC-SL-UT	BC-SL-MX1

JUEGO DE LATIGUILLOS PARA ECG

CONECTOR	DESCRIPCION	No. PARTE	CONECTOR	DESCRIPCION	No. PARTE
	MULTIMARCA; BCL, CRITICARE, DATA SCOPE, GOLDWAY, IVY, MINDRAY, MDE, PHYSIO-CONTROL, NELLCOR, PHILIPS, SPACELABS, WELCH ALLYN, ZOLL	D3-90 S/P D5-90 S/P		MULTIMARCA; BCL, CRITICARE, GE MEDICAL, IVY, MDE, PHYSIO-CONTROL, NELLCOR, PHILIPS, SPACELABS, WA, ZOLL	LL3-90 S/P LL5-90 S/P
	DATASCOPE PASSPORT V	DTS-90 S/P		DATEX	DX3-90 S/P DX5-90 S/P
	DRAGER/ SIEMENS	SM3-90 S/P		MARQUETTE	MQ3-90 S/P MQ5-90 S/P
	MEK	-		MENNEN ENVOY	MN3-90 S/P MN5-90 S/P
	MENNEN	-		MINDRAY	SM3-90 S/P SM5-90 S/P
	NIHON KOHDEN	NKB3-90 S/P NKB6-90 S/P		PHILIPS 12 PINES	AA3-90 S/P AA5-90 S/P
	PHILIPS 8 PINES	AA3-90 S/P AA5-90 S/P		PHYSIO CONTROL	-
	PPG/HELLIGE	DX3-90 S/P DX5-90 S/P		SPACELABS	SL3-90 S/P SL5-90 S/P



MANGUERAS DE PRESION NO INVASIVA

CONECTOR	DESCRIPCION	No. PARTE	CONECTOR	DESCRIPCION	No. PARTE
 	MANGUERA CON CONEXION PARA MONITOR PHILIPS	HS-16-15 HSN-16-20 (NEO)	 	MANGUERA CON CONEXION PARA MONITOR GOLDWAY O SIMILARES	HS-09-09 HSN-09-09 (NEO)
 	MANGUERA CON CONEXION PARA MONITOR SPACELAB	HS-15-15 HSN-15-20 (NEO)	 	MANGUERA CON CONEXION PARA MONITOR MARQUETTE	HD-24-17 HDN-24-27 (NEO)
 	MANGUERA CON CONEXION PARA MONITOR GE-MARQUETTE	HD-22-17 HDN-22-27 (NEO)	 	MANGUERA CON CONEXION PARA MONITOR NIHON KOHEN	HD-30-18 HDN-30-20 (NEO)
 	MANGUERA CON CONEXION PARA MONITOR CRITICARE O DATASCOPE, CRITICARE, SPACELABS, WA, ANTIGUOS	HS-04-07 HSN-04-20 (NEO)	 	MANGUERA CON CONEXION PARA MONITOR CRITIKON	HD-09-09 HDN-09-27 (NEO)
 	MANGUERA CON CONEXION PARA MONITOR DINAMAP	HD-25-09 HDN-25-27 (NEO)	 	MANGUERA CON CONEXION PARA MONITOR DATEX	HD-22-17/18 HDN-22-27 (NEO)
 	MANGUERA CON CONEXION PARA MONITOR DRAGER	HS-40-15 HSN-40-20 (NEO)			

SENSOR DE SPO2 TIPO CLIP

CONECTOR	DESCRIPCION	No. PARTE	CONECTOR	DESCRIPCION	No. PARTE
	ARTEMA	F-2712		SIMED	F-3812
	BCI	F-3222-12		BCI	F-3229-36
	BCI	F-3222-30		CRITICARE	F-3282-9
	CRITICARE	F-3282-30		CRITICARE	F-3282-36
	CRITIKON	F-3112		CRITIKON	F-3912-1
	DATASCOPE	F-3312-9		DATASCOPE	F-3312-36
	DATEX	F-3512-9		DATEX	F-3512-40
	HP	F-2412		HP	F-2414-15
	INVIVO	F-2912		KONTRON	F-2812
	NELLCOR	F-3212-9		NELLCOR	F-3212-15
	NELLCOR	F-3212-31		NIHON KOHDEN	F-2203-9

CONECTOR	DESCRIPCION	No. PARTE	CONECTOR	DESCRIPCION	No. PARTE
	NIHON KOHDEN	F-2203-16		NONIN	F-3012
	NIHON KOHDEN	F-2202-1		NOVAMETRIX	F-3263
	NOVAMETRIX	F-3262-9		NOVAMETRIX	F-3262
	NOVAMETRIX	F-3262-1		OHMEDA	F-3412-9
	OHMEDA	F-3412-10		PACE TECH	F-3712
	OHMEDA	F-3412		SENSORMEDICS	F-3112-40
	PALCO	F-2112-24		PALCO	F-2112
	SENSORMEDICS	F-3912		SPACELABS	F-3612
	SPACELAB	F-3613		S&W	F-2613

CONECTOR	DESCRIPCION	No. PARTE	CONECTOR	DESCRIPCION	No. PARTE
	S&W	F-2612		DATEX - OHMEDA S/S FM PORT	F-3513-30

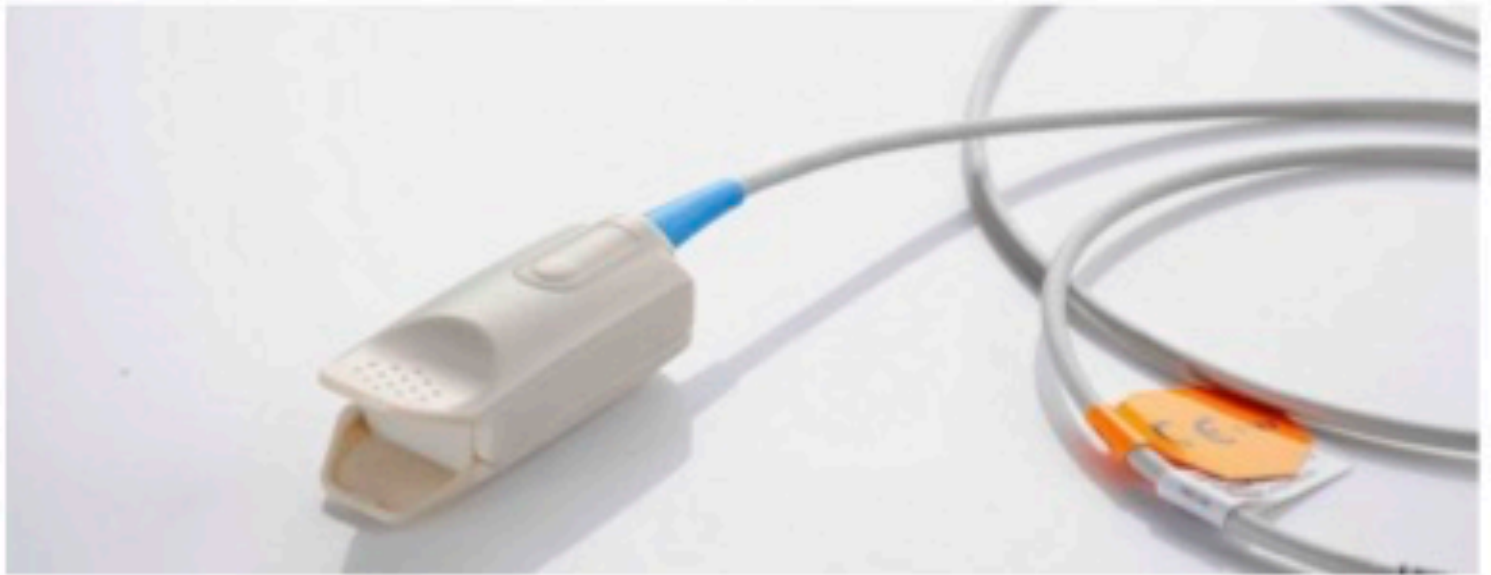

SENSOR DE SPO2 TIPO MULTISITIO

CONECTOR	DESCRIPCION	No. PARTE	CONECTOR	DESCRIPCION	No. PARTE
	ARTEMA	Y-2277		SIMED	Y-2317
	BCI	Y-2227		CRITICARE	Y-2287-36
	CRITICARE	Y-2287-9		CRITIKON	Y-2327-1
	CRITIKON	Y-2337-9		DATASCOPE	Y-2297-36
	DATASCOPE	Y-2297-9		DATEX	Y-2257-40
	DATEX	Y-2257-9		HP	Y-2387
	INVIVO	Y-2357		KONTRON	Y-2367
	NELLCOR	Y-2217-9		NELLCORE	Y-2217-31
	NIHON KOHDEN	Y-2203-16		NIHON KOHDEN	Y-2207-9
	NIHON KOHDEN	Y-2207		NOVAMETRIX	Y-2267
	NONIN	Y-2237		NOVAMETRIX	Y-2267-9

CONECTOR	DESCRIPCION	No. PARTE	CONECTOR	DESCRIPCION	No. PARTE
	NOVAMETRIX	Y-2267-1		OHMEDA	Y-2247
	PACE TECH	Y-2347		OHMEDA	Y-2247-9
	SENSORMEDICS	Y-2337-40		SENSORMEDICS	Y-2327
	S&W	Y-2377		SPACELABS	Y-2307
	BANDA PARA SENSOR MULTISITIO	E023-12			







SENSOR DE SPO2 CONEXION DIRECTA TIPO OREJA

CONECTOR	DESCRIPCION	No. PARTE	CONECTOR	DESCRIPCION	No. PARTE
	DATEX 90 CM LONG. REQUIERE EXTENSION	ES-3512-9		NELLCOR 90 CM LONG. REQUIERE EXTENSION	ES-3212-9



SENSOR DE SPO2 TIPO CLIP

CONECTOR	DESCRIPCION	Nº. PARTE	CONECTOR	DESCRIPCION	Nº. PARTE
	BCI DB9	U410-06		BCI LEMO	U410-76
	CRITICARE LEMO	U410-05		CRITICARE D89	U410-75
	DATEX	U410-09		DATASCOPE	U410-75
	GE MARQUETTE NELLCOR OX	U410-21P		GE MARQUETTE NELLCOR	U410-21
	GE OHMEDA TRUSAT	U410-60		GOLDWAY	U410-37
	INVIVO NELLCOR	U410-14		INVIVO MASIMO	U410-14M
	MASIMO	U410-15		MEK	U410-26
	MINDRAY/MEK	U410-29		NELLCOR	U410-69
	NELLCOR OXI D89	U410-01P		NELLCOR OXIMAX	U410-70
	NIHON KOHDEN	U410-36		NOVAMETRIX	U410-03

CONECTOR	DESCRIPCION	No. PARTE	CONECTOR	DESCRIPCION	No. PARTE
	OHMEDA	U410-02		PHILIPS	U410-91
	PHILIPS	U410-20		SPACELABS	U410-74
	DATEX OHMEDA	U403-127			



SENSOR DE SPO2 TIPO MULTISITIO

CONECTOR	DESCRIPCION	No. PARTE	CONECTOR	DESCRIPCION	No. PARTE
	8CI DB9	U810-05		CRITICARE LEMO	U810-75
	8CI LEMO	U810-76		CRITICARE DB9	U810-75
	DATEX	U810-09		DATASCOPE	U810-07
	GE MARQUETTE NELLCOR	U810-21		GE MARQUETTE NELLCOR OX	U810-21P
	GOLDWAY	U810-37		INVVO NELLCOR	U810-14
	INVVO MASIMO	U810-14M		MEK	U810-26
	MASI	U810-15		MASI	U803-125
	GE OHMEDA TRUSAT	U810-60		NELLCOR	U810-69
	NELLCOR OXIMAX	U810-70		NELLCOR DB9	U801-01
	NELLCOR OXI DB9	U801-01P		NIHON KOHDEN	U810-36

CONECTOR	DESCRIPCION	No. PARTE	CONECTOR	DESCRIPCION	No. PARTE
	NOVAMETRIX 512/513/710/715	U803-73		NOVAMETRIX	U810-03
	PHILIPS	U810-91 U610-91 (Wrap o Tipo L)		OHMEDA	U810-02
	PHILIPS	U810-20		SPACELABS NOVAMETRIX	U810-04
	SPACELABS	U810-74		CLIP PARA SENSOR MULTISITIO	UEC-9



SENSOR DE SPO2 CONEXION DIRECTA TIPO SILICON









CONECTOR	DESCRIPCION	No. PARTE	CONECTOR	DESCRIPCION	No. PARTE
	BCI DB9	U4015-06		BCI LEMO	U4105-76
	CRITICARE DB9	U4105-75		CRITICARE LEMO	U4105-76
	DATASCOPE	U4105-07		DATEX	U4105-09
	OHMEDA	U4105-02		GE MARQUETTE NELLCOR	U4105-21
	GE MARQUETTE NELLCOR OX	U4105-21P		GOLDWAY	U4105-37
	INVIVO NELLCOR	U4105-14		INVIVO MASIMO	U4105-14M
	MASIMO	U4105-15		MEX	U4105-26
	NELLCOR OXIMAX	U4105-70		NELLCOR	U4105-69
	NELLCOR OXIMAX	U4105-01P		NELLCOR DB9	U4105-01
	NELLCOR	U710-85		NOVAMETRIX	U4105-03
	NIHON KOHDEN	U4105-36		NIHON KOHDEN	U4105-16

CONECTOR	DESCRIPCION	No. PARTE	CONECTOR	DESCRIPCION	No. PARTE
	PHILIPS	U4105-91		PHILIPS	U4105-20
	SPACELABS	U4105-74		SPACELABS NOVAMETRIX	U4105-04



SENSOR DE SPO2 DESECHABLES



CONECTOR	COMPATIBILIDAD	WRAP UNIVERSAL
	BCI	DW-2221-6
	CRITICARE	DW--2281-6
	DATEX	DW-2251-6
	NELLCOR	DW-2211-6
	NELLCOR	N543-01X
	NIHON KOHDEN	DW-2201-6
	NOVAMETRIX	DW-2261-6
	OHMEDA	DW-2241-6
	MASI	N543-125



SENSOR DE TEMPERATURA

CONECTOR	DESCRIPCION	No. PARTE	CONECTOR	DESCRIPCION	No. PARTE
	YSI 400 ADULTO MARQUETTE, SPACELABS, CSI	T2252-AS		YSI 400 ESOFAGICO MARQUETTE, SPACELABS, CSI	T2252-AG
	YSI 400 PEDIATRICO MARQUETTE, SPACELABS, CSI	T2252-AS		YSI 700 ADULTO MARQUETTE, SPACELABS, CSI	T700-AS
	YSI 700 ESOFAGICO MARQUETTE, SPACELABS, CSI	T700-AG		YSI 700 PEDIATRICO MARQUETTE, SPACELABS, CSI	T700-AS
	PHILIPS ADULTO	THP-AS		PHILIPS ESOFAGICO	THP-AG
	PHILIPS PEDIATRICO	THP-AS		SIEMENS PEDIATRICO	TSM-AS
	SIEMENS ESOFAGICO	TSM-AG		SIEMENS PEDIATRICO	TSM-AS
	MINDRAY TS/T8	TMR-AS		MINDRAY TS/T8	TMR-AG
	GE MARQUETTE ADAPTADOR DUAL DE TEMPERATURA YSI400	TMQ400- AD/2		SPACELABS ADAPTADOR DUAL DE TEMPERATURA YSI400	TSL-AD/2







TRANSDUCTOR IBP

	CONECTOR	DESCRIPCION	No. PARTE
	 	ABBORT / MEDEX	DP-MX-20
	 	EDWARD	DP-ED-20
	 	B. BRUAN	DP-BB-20
	 	UTAH	DP-UT-20



ECG

BeneView, iPM, iMEC series monitors, BeneHeart defibrillator

CONECTOR	DESCRIPCION	No. PARTE	CONECTOR	DESCRIPCION	No. PARTE
	ECG TRUNK CABLE: 3/5-LEAD, EACH ADU/PED, 12 PIN, DEFIB-PROOF, AHA/IEC, 3M	0010-30- 42719		5 LEAD ECG WIRES, SNAP, ADU, TPU, AHA, 0.6M	0010-30- 42735
	ECG TRUNK CABLE: 3-LEAD, PED/NEO, EACH 12 PIN, DEFIB-PROOF, AHA/IEC, 3M	0010-30- 42720		3-LEAD ECG WIRES, CLIP, NEO, TPU, AHA, 0.6M	0010-30- 42896
	ECG TRUNK CABLE, 3-LEAD, PED/NEO, 12 PIN, TPU, AHA/IEC, 3M	040- 000754-00			

PM, MEC series monitors

CONECTOR	DESCRIPCION	No. PARTE	CONECTOR	DESCRIPCION	No. PARTE
	ECG TRUNK CABLE: 3/5-LEAD, ADU/PED, 6 PIN, DEFIB-PROOF, TPU, AHA/IEC, 3M	0010-30- 42782		3-LEAD ECG WIRES, CLIP, NEO, TPU, AHA, 0.6M	0010-30- 42896
	5-LEAD ECG WIRES, SNAP, ADU, TPU, AHA, 0.6M	0010-30- 42735		ECG TRUNK CABLE, 3-LEAD, PED/NEO, 6 PIN, TPU, AHA/IEC, 3M	040-000753- 00
	ECG TRUNK CABLE: 3-LEAD, NEO, 6 PIN, DEFIB-PROOF, TPU, AHA/IEC, 3M	0010-30- 12377			

Match with 3-lead Neonatal cables (040-000754-00, 040-000753-00)

CONECTOR	DESCRIPCION	No. PARTE	CONECTOR	DESCRIPCION	No. PARTE
	NEONATAL 3-LEAD PRE-WIRED ELECTRODES, RADIO OPAQUE, AAMI, 18"(45CM)	0681-00- 0098-01		NEONATAL 3-LEAD PRE-WIRED ELECTRODES, RADIO TRANSLUCENT, AAMI, 18" (45CM)	0681-00- 0098-02

SpO2

MINDRAY: BeneView, iPM, iMEC series monitors, BeneHeart defibrillator

CONECTOR	DESCRIPCION	No. PARTE
	MINDRAY SPO2 EXTENSION CABLE, 7 PIN, 2.5M	0010-20-42710

MINDRAY: PM, MEC series monitors

CONECTOR	DESCRIPCION	No. PARTE
	MINDRAY SPO2 EXTENSION CABLE, 6 PIN, 2.5M	0010-20-42594

MINDRAY: Mindray SpO2 Cables and PM-50/60 pulse oximeter

CONECTOR	DESCRIPCION	No. PARTE	CONECTOR	DESCRIPCION	No. PARTE
	512F REUSABLE SENSOR, ADULT, FINGER-CLIP, 1.1M	512F-30-28263		512G REUSABLE SENSOR, PEDIATRIC, FINGER-TIP, 1.1M	512G-30-90607
	512H REUSABLE SENSOR, PEDIATRIC, FINGER-CLIP, 1.1M	512H-30-79061		5188 REUSABLE SENSOR, WITH SILICON WRAP, NEO, FOOT, 1.1M	5188-30-72107
	512E REUSABLE SENSOR, ADULT, FINGER-TIP, 1.1M	512E-30-90390		520N SINGLE PATIENT USE SENSOR, NEO, <3KG, 1M	520N-30-64401

MASIMO: BeneView, iPM, iMEC series monitors, BeneHeart defibrillators

CONECTOR	DESCRIPCION	No. PARTE
	MASIMO SPO2 EXTENSION CABLE, 8 PIN, 2.9M, PURPLE CONNECTOR	040-000332-00

MASIMO: Masimo Cables (0010-30-42738, 040-000332-00, 0010-30-42625)

CONECTOR	DESCRIPCION	No. PARTE	CONECTOR	DESCRIPCION	No. PARTE
	MASIMO REUSABLE SENSOR, ADULT (>30 KG), 0.9M	0010-10-42600		MASIMO MULTISITE REUSABLE SENSOR, ADULT/PEDIATRIC/NEO, 0.9M	0010-10-43016

SpO2

NELLCOR: BeneView, iPM, IMEC series monitors, BeneHeart defibrillators

CONECTOR	DESCRIPCION	No. PARTE
	NELLCOR SPO2 EXTENSION CABLE, 8 PIN, 2.5M	0010-20-42712

NELLCOR: VS-800, PM series monitors

CONECTOR	DESCRIPCION	No. PARTE
	NELLCOR SPO2 EXTENSION CABLE, 8 PIN, 2.5M	0010-20-42595

NELLCOR: Nellcor Cables (0010-20-42712, 0010-20-42595)

CONECTOR	DESCRIPCION	No. PARTE	CONECTOR	DESCRIPCION	No. PARTE
	NELLCOR REUSABLE SENSOR, ADULT, 1M	9000-10-05161		NELLCOR DISPOSABLE SENSOR, ADULT/NEO, >40KG OR <3KG, 0.5M	0010-10-12205
	NELLCOR MULTISITE SENSOR, ADULT/PEDIATRIC/INF/NEO, 1M	0010-10-12476			

NIBP

NIBP: BeneView, iPM, IMEC series monitors, BeneHeart defibrillator

CONECTOR	DESCRIPCION	No. PARTE	CONECTOR	DESCRIPCION	No. PARTE
	NIBP TUBING, ADU/PED/INF, WITH CONNECTORS, 3M	6200-30-09688		NIBP TUBING, NEO, WITH CONNECTORS, 3M	6200-30-11560

NIBP: VS-800, MEC, PM series monitors

CONECTOR	DESCRIPCION	No. PARTE	CONECTOR	DESCRIPCION	No. PARTE
	NIBP TUBING, ADU/PED/INF, 3 M	5098-30-06259		NIBP TUBING, NEO, 3 M	5098-30-06260

Non-invasive Blood Pressure Cuff (Reusable) CM1200 Series

CONECTOR	DESCRIPCION	No. PARTE	CONECTOR	DESCRIPCION	No. PARTE
	REUSABLE CUFF, SMALL INF, 7-13 CM, WITH CONNECTOR	115-002480-00		REUSABLE CUFF, ADU, 25-35 CM, WITH CONNECTOR	0010-30-12159
	REUSABLE CUFF, INF, 10-19 CM, WITH CONNECTOR	0010-30-12157		REUSABLE CUFF, LARGE ADU, 33-47 CM, WITH CONNECTOR	0010-30-12160
	REUSABLE CUFF, CHILD, 18-26 CM, WITH CONNECTOR	0010-30-12158		REUSABLE CUFF, THIGH, 46-66 CM, WITH CONNECTOR	0010-30-12161

CM1300 Series

CONECTOR	DESCRIPCION	No. PARTE	CONECTOR	DESCRIPCION	No. PARTE
	REUSABLE BLADDERLESS CUFF, SMALL INF, 7-13 CM, WITH CONNECTOR	040-000968-00		REUSABLE BLADDERLESS CUFF, ADU, 25-35 CM, WITH CONNECTOR	040-000983-00
	REUSABLE BLADDERLESS CUFF, INF, 10-19 CM, WITH CONNECTOR	040-000973-00		REUSABLE BLADDERLESS CUFF, LARGE ADU, 33-47CM, WITH CONNECTOR	040-000988-00
	REUSABLE BLADDERLESS CUFF, CHILD, 18-26CM, WITH CONNECTOR	040-000978-00		REUSABLE BLADDERLESS CUFF, THIGH, 46-66 CM, WITH CONNECTOR	040-000993-00

CM1500 Series

CONECTOR	DESCRIPCION	No. PARTE
	SINGLE-PATIENT USE CUFF, ADU, 25-35 CM	0018-30-70699

Temperature

BeneView, iPM, IMEC series monitors, BeneHeart defibrillator

CONECTOR	DESCRIPCION	No. PARTE	CONECTOR	DESCRIPCION	No. PARTE
	REUSABLE TEMP PROBE, PED/NEO, ESOPHAGEAL/RECTAL, 2 PIN, 3M	0011-30-37394		REUSABLE TEMP PROBE, ADU, SKIN, 2 PIN, 3.6M	0011-30-37393

MEC, PM series monitors

CONECTOR	DESCRIPCION	No. PARTE	CONECTOR	DESCRIPCION	No. PARTE
	REUSABLE TEMP PROBE, PED/NEO, ESOPHAGEAL/RECTAL, AUDIO, 3M	0011-30-90441		REUSABLE TEMP PROBE, ADU, SKIN, AUDIO, 3.6M	0011-30-90442

CO₂

BeneView, iPM, iMEC, PM, MEC-2000 series monitors, BeneHeart defibrillator

CONECTOR	DESCRIPCION	No. PARTE	CONECTOR	DESCRIPCION	No. PARTE
	DRYLINE WATER TRAP, ADU/PED	9200-10-10530		SAMPLING LINE, NEO, 2.5 M	9200-10-10555
	SAMPLING LINE, ADU/PED, 2.5 M	9200-10-10533		CO ₂ NASAL SAMPLE CANNULA, ADU, 2.1M	M02A-10-25937
	DRYLINE WATER TRAP, NEO	9200-10-10574		CO ₂ NASAL SAMPLE CANNULA, PED, 2.1M	M02A-10-25938
	DRYLINE AIRWAY ADAPTER, STRAIGHT, ADU/PED	9000-10-07486		CO ₂ NASAL SAMPLE CANNULA, INF, 2.1M	M02B-10-64509

Micro-stream CO₂ Accessories (Oridion)

CONECTOR	DESCRIPCION	No. PARTE	CONECTOR	DESCRIPCION	No. PARTE
	SAMPLING LINE, NEO, 2.5 M	9200-10-10555		CO ₂ NASAL SAMPLE CANNULA, INF, 2.1M	M02B-10-64509
	CO ₂ NASAL SAMPLE CANNULA, ADU, 2.1M	M02A-10-25937		DRYLINE AIRWAY ADAPTER, STRAIGHT, ADU/PED	9000-10-07486
	CO ₂ NASAL SAMPLE CANNULA, PED, 2.1M	M02A-10-25938			

CO
BeneView, IPM series monitors

CONECTOR	DESCRIPCION	No. PARTE
	12 PIN C.O. CABLE	0010-30-42743

MEC-2000, PM series monitors

CONECTOR	DESCRIPCION	No. PARTE
	6 PIN C.O. CABLE	900E-30-04952

Micro-stream CO2 Accessories (Oridion)

CONECTOR	DESCRIPCION	No. PARTE	CONECTOR	DESCRIPCION	No. PARTE
	INJECTION LIQUID TEMPERATURE SENSOR (BD)	6000-10-02079		12CC CONTROL SYRINGE W/ROTATOR (MEDEX)	6000-10-02081
	INJECTION LIQUID TEMPERATURE SENSOR HOUSING (BD)	6000-10-02080			

Cardiac Output Accessory Kit
BeneView, IPM series monitors

CONECTOR	DESCRIPCION	No. PARTE
	C.O. ACCESSORY KIT	6800-30-50617

MEC-2000, PM SERIES MONITORS

CONECTOR	DESCRIPCION	No. PARTE
	C.O. ACCESSORY KIT	6000-30-02165

DEFIBRILLATOR
BeneHeart defibrillator D6/D3

CONECTOR	DESCRIPCION	No. PARTE
	CABLE OF ELECTRODE PADS WITH TEST LOAD (50 OHM)	040-000545-00
	MULTIFUNCTION ELECTRODE PADS, ADULT, DISPOSABLE (5SETS/PACK)	0651-30-77007
	MULTIFUNCTION ELECTRODE PADS, PEDIATRIC, DISPOSABLE (5SETS/PACK)	0651-30-77008



S.P.L. Elektronik

SIMULADORES

SEGURIDAD ELECTRICA

GM-610



GM-300



GM-410



Sistema de pruebas para comprobar la seguridad eléctrica de acuerdo con:
*IEC 60601 / IEC 62353 / IEC 61010 / VDE 0701-0702
 MPG / MPBetreibV / BetrSichV / BGV A3*

- Pantalla táctil o funcionamiento por PC
- Enchufe PS2 para teclado PC externo o un escáner de código de barras
- Memoria interna para las instrucciones y los protocolos de pruebas 200
- 25 A medida PE según IEC 60601
- Caja de metal ligero robusto
- Configuración de idioma

Sistema de pruebas para comprobar la seguridad eléctrica según la norma
*IEC 60601 / IEC 62353 / IEC 61010 / VDE 0701 a 0702
 MPG / MPBetreibV / BetrSichV / BGV A3*

- Menú guiado la operación del cursor o PC-operación
- Conector PS/2 para un teclado externo o un escáner de código de barras
- Memoria interna de 125 mediciones o usuario - dispositivos
- Medición automática o multímetro
- 25 A medida PE según IEC 6060
- Configuración de idioma

Sistema de pruebas para comprobar la seguridad eléctrica según la norma
*IEC 60601 / IEC 62353 / IEC 61010 / VDE 0701 a 0702
 MPG / MPBetreibV / BetrSichV / BGV A3*

- Operación por medio de PC
- Medición automática o multímetro
- Caja de metal ligero robusto
- 25 A medida PE según IEC 60601
- Perfecto para el trabajo móvil con laptop

SIMULADORES

MODELO

STIMU-600



Sistema para pruebas de función de equipo electro estimulación de conformidad con la norma IEC 60601-2-10

- Pantalla táctil o el funcionamiento por PC
- Representación gráfica de señales
- Medición de corriente y tensión efectiva
- Medición de los valores de corriente de interferencia
- Identificación de latidos
- Configuración de idioma específica del usuario
- Acumulador operacional de dispositivo

TBH-400



Sistema para pruebas de función de termómetros clínicos, cardiaca salida, dispositivos de presión arterial invasiva y no invasiva

- Salida de temperatura de 0 - 70 ° C
- Salida de varias señales de PNI
- Salida de señal de IBP dinámica y estática
- 4 salidas cardiacas diferentes seleccionables
- Aprobado para calibración en el termómetro médico

HF-400



Analizador Electroquirúrgico para pruebas de función de equipo quirúrgico de alta frecuencia

- Menú guiado la operación del cursor o PC-operación
- HF - medida de potencia
- HF - medida de tensión
- HF - Medición de corriente
- HF - la medición de corriente de fuga
- Carga de prueba resistencias 10 Ohm, 25-6375 ohmios en pasos de 25 Ohm
- 6 seleccionable de resistencia pre
- Configuración de idioma

IN-400



Bombas dispositivo de prueba para las pruebas de función de infusiones

- Para bombas peristálticas o jeringas
- Menú guiado la operación del cursor o PC-operación
- 1 - o la versión de 2 canales disponibles
- Prueba de llamada de enfermera integrada
- Evaluación gráfica controlada por software posible (diagrama de puesta en marcha, la curva de trompeta)
- Caja de metal ligero robusto
- Configuración de idioma específica del usuario
- Maleta opcional

MODELO
DP-300

DESCRIPCION

Sistema de ensayo para pruebas de función de desfibriladores / marcapasos externos y simulación ECG

- Operación del acumulador
- Cursor controlado por menú o el control de PC
- Visualización gráfica de la trama de descarga
- de medición de bifásica de impulsos es posible
- Output ECG para todos revulsiones ECG
- Detener la función de reloj para la carga y descarga de los tiempos
- Configuración de idioma

ES-300

Prueba del sistema ES-300 para pruebas de función de dispositivos de ECG

- ECG salida de impulsos
- Señales periódicas
- Salida de la arritmia
- Salidas de marcapasos
- La simulación de la respiración
- Salida de señal de acuerdo con la norma IEC 60601
- Configuración de idioma

SIMULADORES MODULARES
MODELO
GS-X
DESCRIPCION

El Módulo de pruebas GS para probar la seguridad eléctrica de acuerdo con
 IEC 62353 / IEC 61010 y VDE 0701-0702
 MPG / MPBetreibV / BetrSichV / BGV A3

- Para el control de la seguridad eléctrica de acuerdo a la MPG
- para comprobar la seguridad eléctrica en los dispositivos eléctricos generales
- Las mediciones y el funcionamiento automático
- Medición de corriente directa y diferencial

**MODELO
SAFE**
DESCRIPCION

El Módulo de pruebas GS para probar la seguridad eléctrica de acuerdo con
IEC 62353 / IEC 61010 y VDE 0701-0702
MPG / MPBetreibV / BetrSichV / BGV A3

- Para el control de la seguridad eléctrica de acuerdo a la MPG
- Para comprobar la seguridad eléctrica en los dispositivos eléctricos generales
- Las mediciones y el funcionamiento automático
- Medición de corriente directa y diferencial

DEFI

El Módulo de pruebas GS para las pruebas de función de desfibriladores externos

- Visualización gráfica de la trama de descarga
- Medición de bifásica de impulsos es posible
- Salida de ECC sobre paletas o del monitor
- Salida de varias señales de sincronización
- Detener la función de reloj para la carga y descarga de los tiempos

ES

El ES Módulo de pruebas GS para las pruebas de función de dispositivos de ECG

- ECG salida de impulsos
- Señales periódicas
- Salida de la arritmia
- Salidas de marcapasos
- Simulación de la respiración
- salida de señal de acuerdo con la norma IEC 60601

MODELO	DESCRIPCION
<p data-bbox="233 184 383 260">INFU</p> 	<p data-bbox="565 327 1422 394">El Módulo de pruebas GS para las pruebas de función de infusiones bombas</p> <ul data-bbox="613 432 1523 609" style="list-style-type: none">• Para bombas peristálticas o jeringas• Secuencias de medición automática con PC - Software• Medición de presión y volumen de bolo• Prueba de llamada de enfermera integrada• Medición de volumen muy pequeño de 0,1 ml / h es posible
<p data-bbox="263 716 354 751">PACE</p> 	<p data-bbox="565 821 1422 888">El Módulo de pruebas GS para las pruebas de función de marcapasos externos</p> <ul data-bbox="613 926 1425 1102" style="list-style-type: none">• Transtorácica y intracardíacos marcapasos• Registro de sensibilidad automática• Salida de varias señales de sincronización• Demanda y la inhibición de las pruebas de frecuencia• Visualización gráfica de los impulsos de ritmo
<p data-bbox="282 1209 334 1245">HF</p> 	<p data-bbox="565 1304 1536 1371">El Módulo de pruebas GS para las pruebas de función de equipo quirúrgico de alta frecuencia</p> <ul data-bbox="613 1409 1503 1614" style="list-style-type: none">• HF - medida de potencia• HF - medida de tensión• HF - Medición de corriente• HF - la medición de corriente de fuga• carga de prueba resistencias 10 Ohm, 25-6375 ohmios en pasos de 25 Ohm

MODELO
STIMU

DESCRIPCION





El Módulo de pruebas GS para pruebas de la función de los equipos electro-estimulación

- Representación gráfica de señales
- Secuencias de medición automáticas con software para PC
- Medición de los valores de corriente de interferencia
- Identificación de floatings
- Medición de corriente y tensión efectiva



ULTRASONIDO

IMPRESORAS B/N

MODELO	DESCRIPCION
	<p>P-93W IMPRESORA TERMICA MONOCROMATICA, DISEÑO COMPACTO, ALTA VELOCIDAD, MULTIFORMATO, CONEXIÓN POR VIDEO COMPUESTO, MARCA MITSUBISHI</p>
	<p>P-95DW IMPRESORA TERMICA DIGITAL MONOCROMATICA, DE ALTA VELOCIDAD, DISEÑO COMPACTO, MULTIFORMATO, CONEXIÓN POR USB 2.0 MARCA MITSUBISHI</p>

IMPRESORAS COLOR

MODELO	DESCRIPCION
	<p>CP-31W IMPRESORA TERMICA A COLOR ANALOGA, DISEÑO COMPACTO, ALTA VELOCIDAD, MULTIFORMATO, CONEXIÓN POR VIDEO COMPUESTO Y S-VIDEO MARCA MITSUBISHI</p>
	<p>CP-30DW IMPRESORA TERMICA A COLOR DIGITAL, DE ALTA VELOCIDAD, MULTIFORMATO, DISEÑO COMPACTO, CONEXIÓN POR USB 2.0 MARCA MITSUBISHI</p>

PAPEL	
MODELO	DESCRIPCION
	KP-91HG ROLLO DE PAPEL TERMICO DE ALTO BRILLO TIPO GLOSSY, CAJA CON 4 ROLLOS MARCA MITSUBISHI
	KP-65HM ROLLO DE PAPEL TERMICO DE ALTA DENSIDAD, CAJA CON 4 ROLLOS MARCA MITSUBISHI
	K-95HG ROLLO DE PAPEL TERMICO DE ALTO BRILLO TIPO GLOSSY, CAJA CON 5 ROLLOS MARCA MITSUBISHI
	CK-30L PAQUETE DE PAPEL TERMICO PRECORTADO Y CINTA DE TINTA PARA 200 IMPRESIONES MARCA MITSUBISHI



ENVITEC

VENTILACION

SENSORES DE FLUJO

	DESCRIPCIÓN	No. PARTE
	SENSOR DE FLUJO, SPIROQUANT A+ PARA LAS VENTILADORES Y MAQUINAS DE ANESTESIA DRAGER	1000470
	SENSOR DE FLUJO, SPIROQUANT H PARA VENTILADORES HAMILTON	07-00-0001



CELDA DE OXIGENO

CONECTOR	DESCRIPCION	No. PARTE	CONECTOR	DESCRIPCION	No. PARTE
	OHMEDA EXCEL, OXICAP, MAX 1	OOM101		AIR SHIELDS ISOLETTE C200, SERVO 900	OOM102
	DATEX ENGSTROM, PB 7200, TAEMA, HEYER	OOM102-1 OOM102-1HEYM		CRITICARE POET	OOM103
	INVIVO	OOM103-1		IT GAMBERT	OOM103-1M
	SENSORTEC	OOM104		HAMILTON, HUDSON, NEWPORT, SECHRIST, TELEDYNE 17	OOM105
	DATASCOPE	OOM106		HAMILTON, TELEDYNE T1/T2	OOM107
	TELEDYNE C1R/C2R	OOM107-2		OHMEDA AESTIVA, 7900 MONITOR, EXCEL SE	OOM110
	GE, OHMEDA, GIRAFFE	OOM112		DRAGER EVITA, CICERON, OXYCOM, BABYLOG, FABIAN, PM 8030, INCUBATOR 6000	OOM201
	HAMILTON GALILEO RAPHAEL ALLADIN, PB 840, 760, 740, SIEMENS, SERVO 300	OOM202		AIRSHIELDS	OOM202-1
	MINIOX	OOM202-2		STEPHAN STEPHANIE	OOM202-2S
	VIASYS VELA	PSR-75-KE4		OXIQUANT 5	OOI103
	MONITOR DE OXIGEN OXIQUANTS	46-00-0021		NEWPORT 360	PSR-75-KE7
	DATASCOPE	PSR-11-60-08			

CIRCUITOS DE RESPIRACION

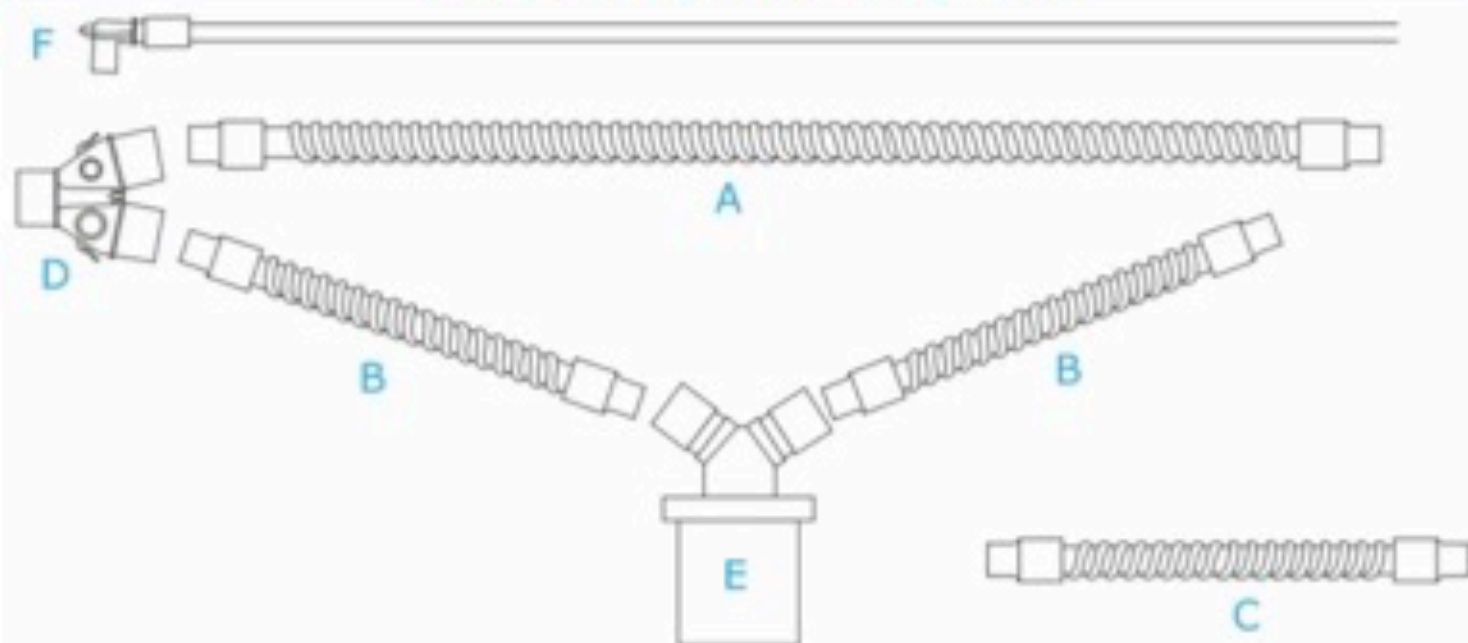

TIPO	A	B	C	D	E	F	No. PARTE
Neonato	60 cm 2 piezas	60 cm 2 piezas	60 cm 1 pieza	•	10 M 2 piezas	•	VA-4132-01
Adulto	75 cm 2 piezas	75 cm 2 piezas	60 cm 1 pieza	•	22M 2 piezas	•	VA-4112-01

www.demim.com.mx



Distribuidora de Equipo Médico e Industrial de México S.A. de C.V.

Bivd Campestre No. 506 Int 202
Col. Jardines del Moral
León, Guanajuato.
CP 37160
Tel. (477) 779 0167

Calle Industria Zapatera No.117
Col. Industria Zapopan Norte
Zapopan, Jalisco.
CP 45130
Tel. (333) 121 0214

FB: DEMIM
www.demim.com.mx
contacto@demim.com.mx

